

CONTROLLER

ATyS C20 / C30

Notice d'utilisation - Operating instructions

F

GB

MAKE YOUR BUSINESS SAFE

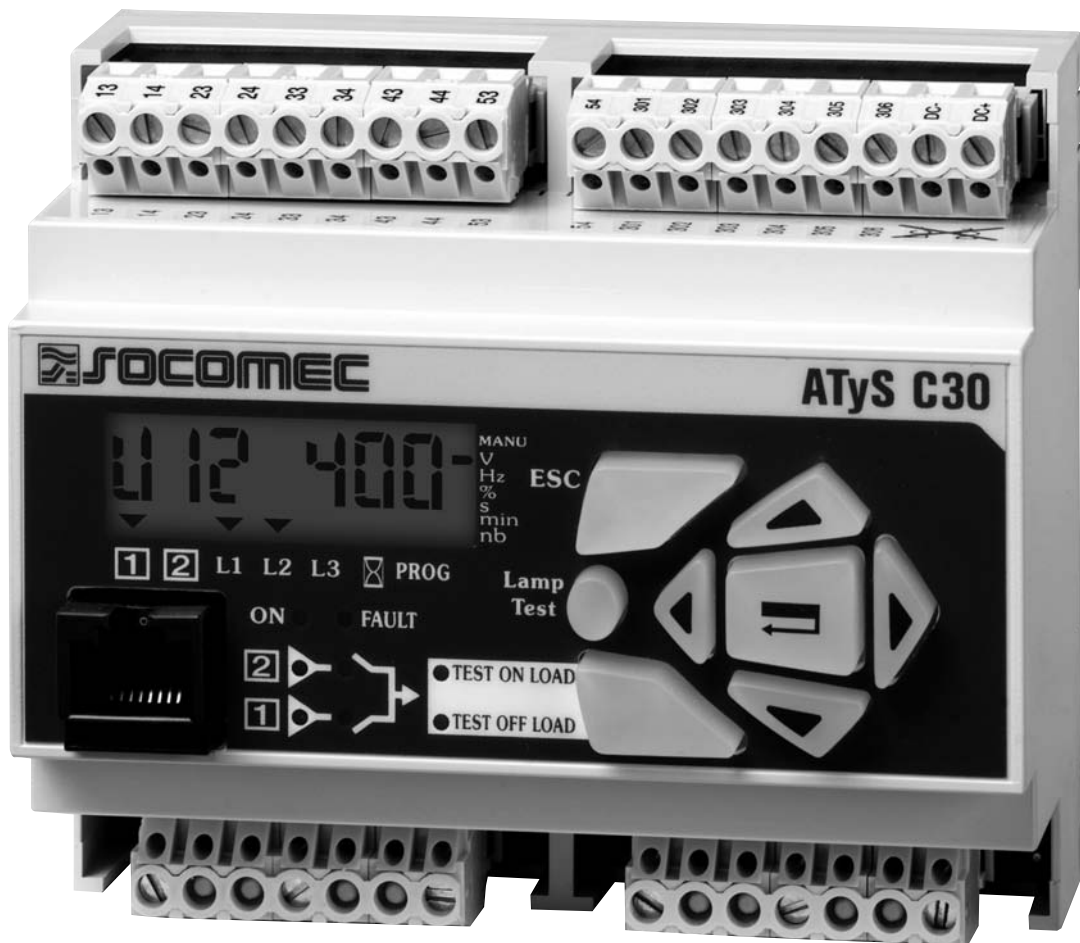

LA GAMME ATyS	3
PRÉSENTATION GÉNÉRALE	4
Présentation des produits	4
INSTALLATION	5
Montage	5
Dimensions	5
Caractéristiques	5
RACCORDEMENTS	6
Circuits de commande	6
Commande électrique	11
FONCTIONNEMENT	12
Présentation	12
Modes d'utilisation	13
Programmation	14
Exploitation	24
Visualisation	26
Séquences automatiques	28
AIDE AU DÉPANNAGE	31
ANNEXES	32
Typologie des réseaux	32
Programmation et câblage ATyS	33

THE ATyS RANGE	35
GENERAL PRESENTATION	36
Product introduction	36
INSTALLATION	37
Mounting	37
Dimensions	37
Characteristics	37
CONNECTIONS	38
Control circuits	38
Electrical operation	43
OPERATION	44
Presentation	44
Operational modes	45
Programming	46
Operation	56
Visualisation	58
Automatic sequences	60
TROUBLESHOOTING GUIDE	63
ANNEXES	64
Network analysis	64
Programming and connections ATyS C30	65

THE **ATyS** RANGE

The **ATyS** family proposes a complete motorised changeover range including electrical and mechanical interlocking. Manual operation is always possible on all the products in case of emergency.

The electric command is realised via a motorised module, electronically driven by 2 types of logic:

- Remote controlled: **ATyS 3** products are controlled by volt free contacts allowing the switch to be driven in 1, 0 or 2 position. These contacts can come from an external control logic.

- Automatic control: **ATyS 6** products integrate all controls, timers and relays required to realise a Normal/Emergency application.

ATyS 6e and **6m** versions also integrate the remote controlled feature.

The motorised and control modules can easily be replaced without disconnecting the power cables.

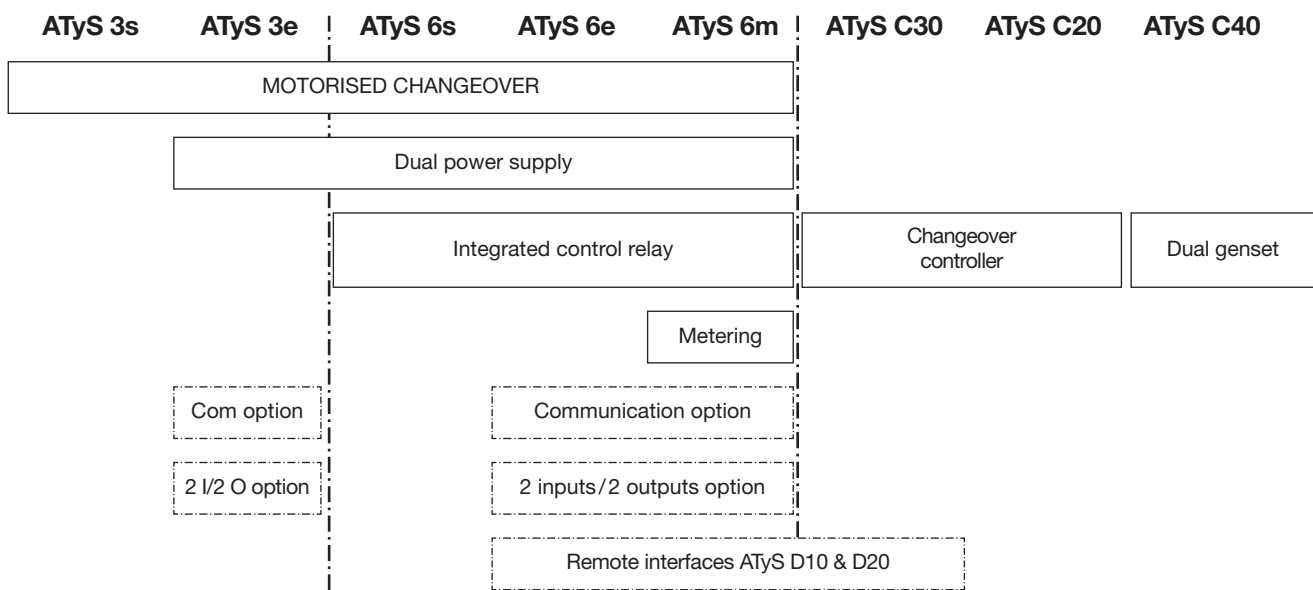

> This instruction manual applies to following products:

- Controller ATyS C20/C30

> Following products are delivered with their own instruction manual:

- ATyS 3s
- ATyS 3e, 6s, 6e
- ATyS 6m
- Remote interfaces ATyS D10 & D20
- Controller ATyS C40.

 For personnel and product safety, please read the contents of these operating instructions carefully before connecting.

Product introduction

ATyS C20

LCD

Control terminals

Modular frame



Voltage sensing and power supply terminals

Keypad

ATyS C30

LCD

Control terminals

Modular frame

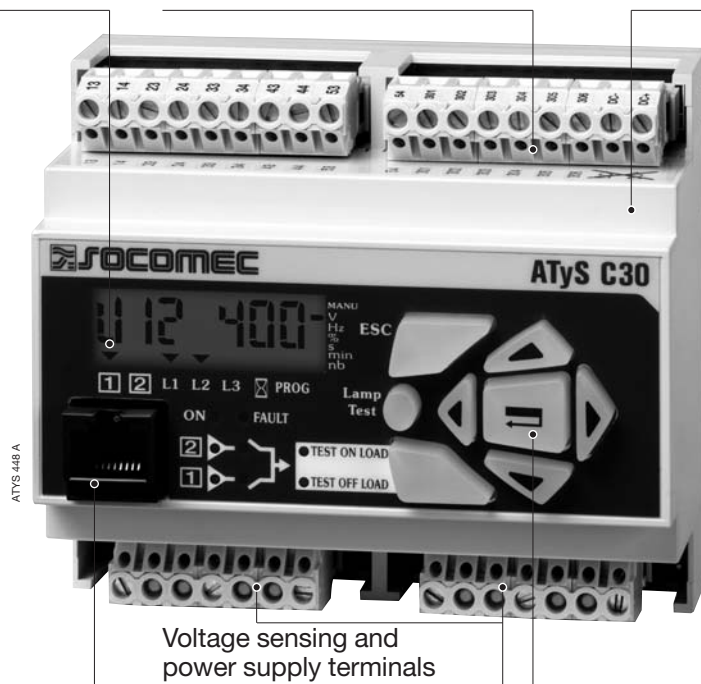

RJ45 terminal

Voltage sensing and power supply terminals

Keypad

Mounting

▶ DIN rail mounting



Dimensions

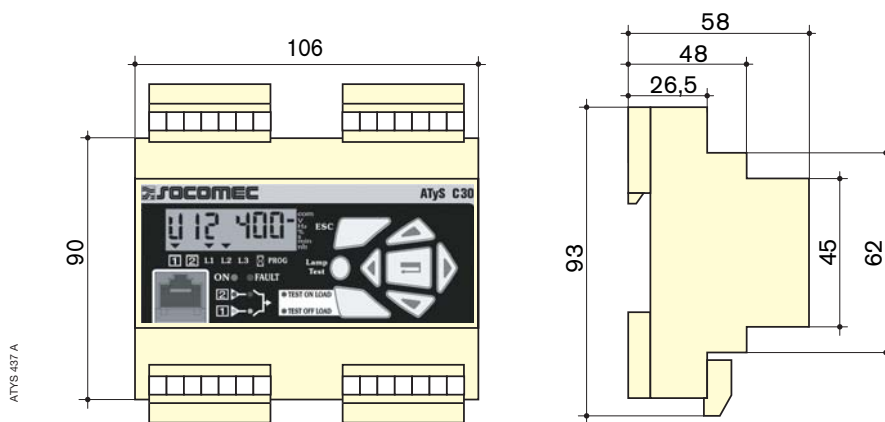

Characteristics

▶ IP

IP2 and class II on front face

▶ Operation

- Temperature: -20 °C to +60 °C
- Humidity: 80 % at 55 °C
95 % at 40 °C

▶ Consumption

7.5 VA max

▶ Measurement category

Cat III

Control circuits

400 Vac (P-P) APPLICATION WITH NEUTRAL CONDUCTOR SWITCHING TYPE TECHNOLOGY

- Configure the type of control logic in impulse mode (see Programming chapter).
- Automatic Power supply 203-205 or 104-106 (see power supply chapter).

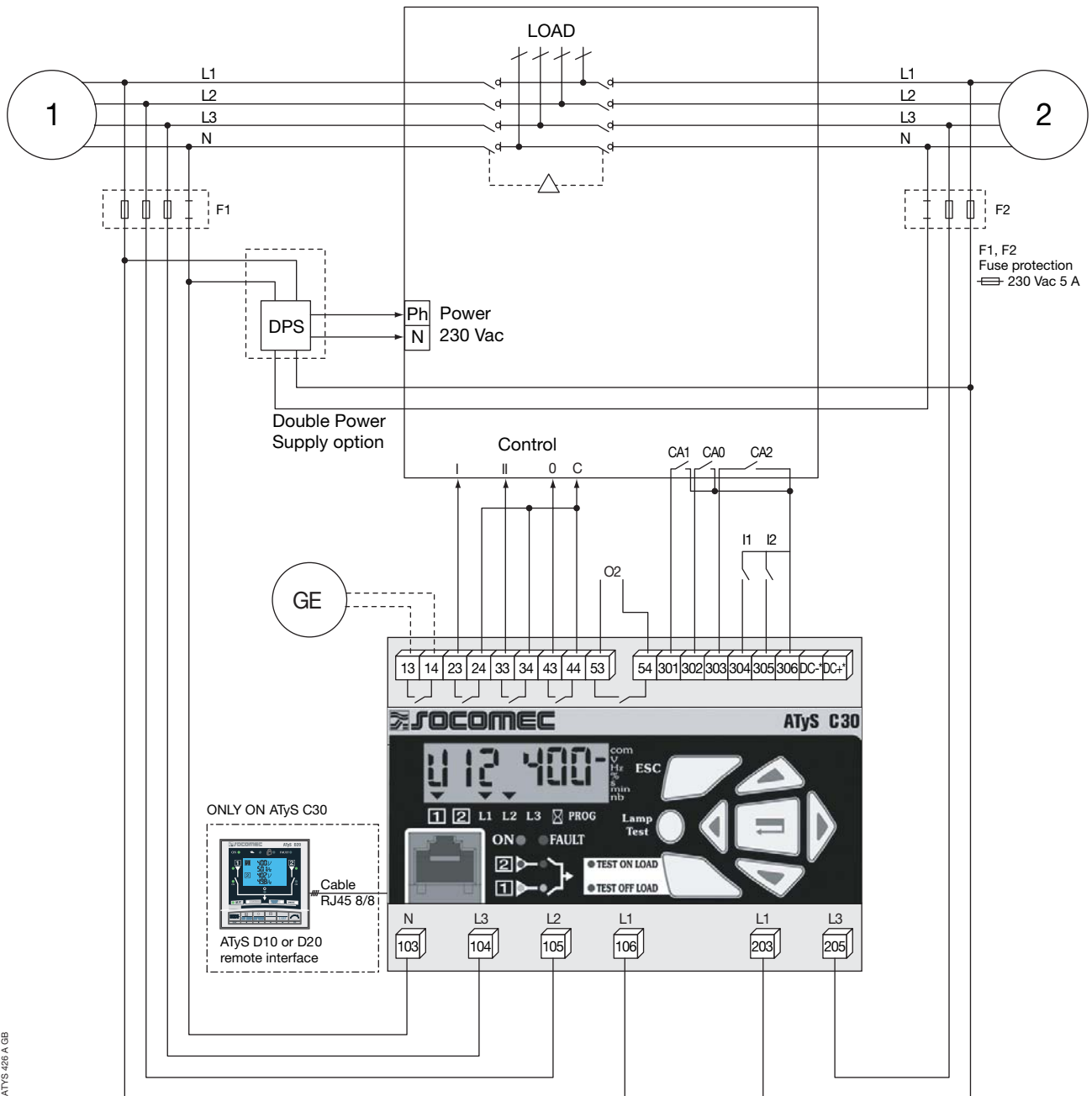

* Only on DC versions.



Maximum control cables length = 10 m.
In case of longer distance, insert control relays.



Remote interfaces maximum connection cable (RJ45) = 3 m.

Control circuits

400 Vac (P-P) APPLICATION WITH NEUTRAL CONDUCTOR CONTACTOR TYPE TECHNOLOGY

- Configure the type of control logic in contactor (see Programming chapter).
- Automatic Power supply 203-205 or 104-106 (see power supply chapter).

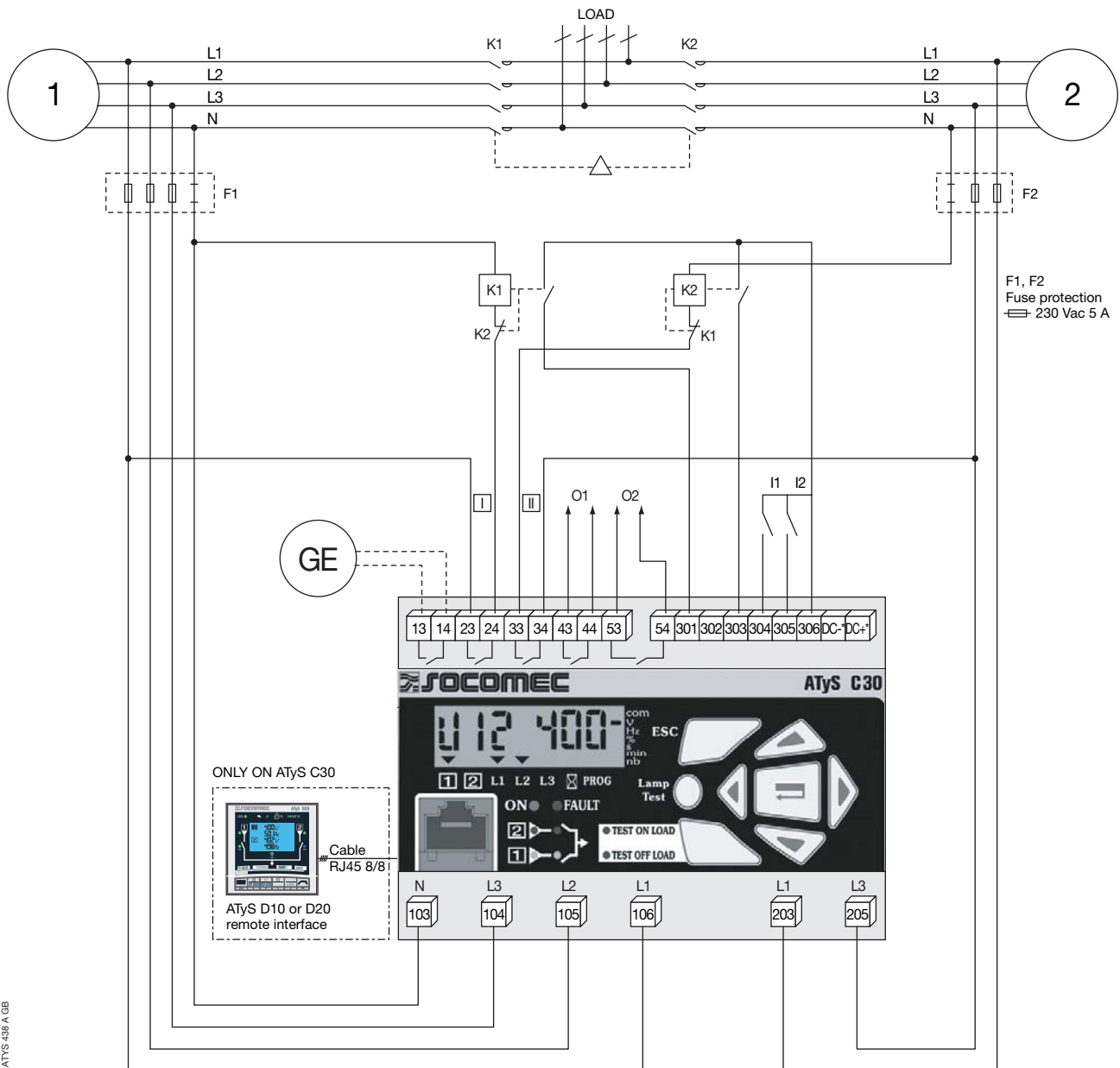

ATyS 438 A GB

* Only on DC versions.

! Maximum control cables length = 10 m. In case of longer distance, insert control relays.

! Remote interfaces maximum connection cable (RJ45) = 3 m.

Control circuits

400 Vac (P-P) APPLICATION WITH NEUTRAL CONDUCTOR CIRCUIT BREAKER TYPE TECHNOLOGY

▶ **Electrical interlocking via external control relays**

- Configure the type of control logic in contactor (see Programming chapter).
- Automatic Power supply 203-205 or 104-106 (see power supply chapter).

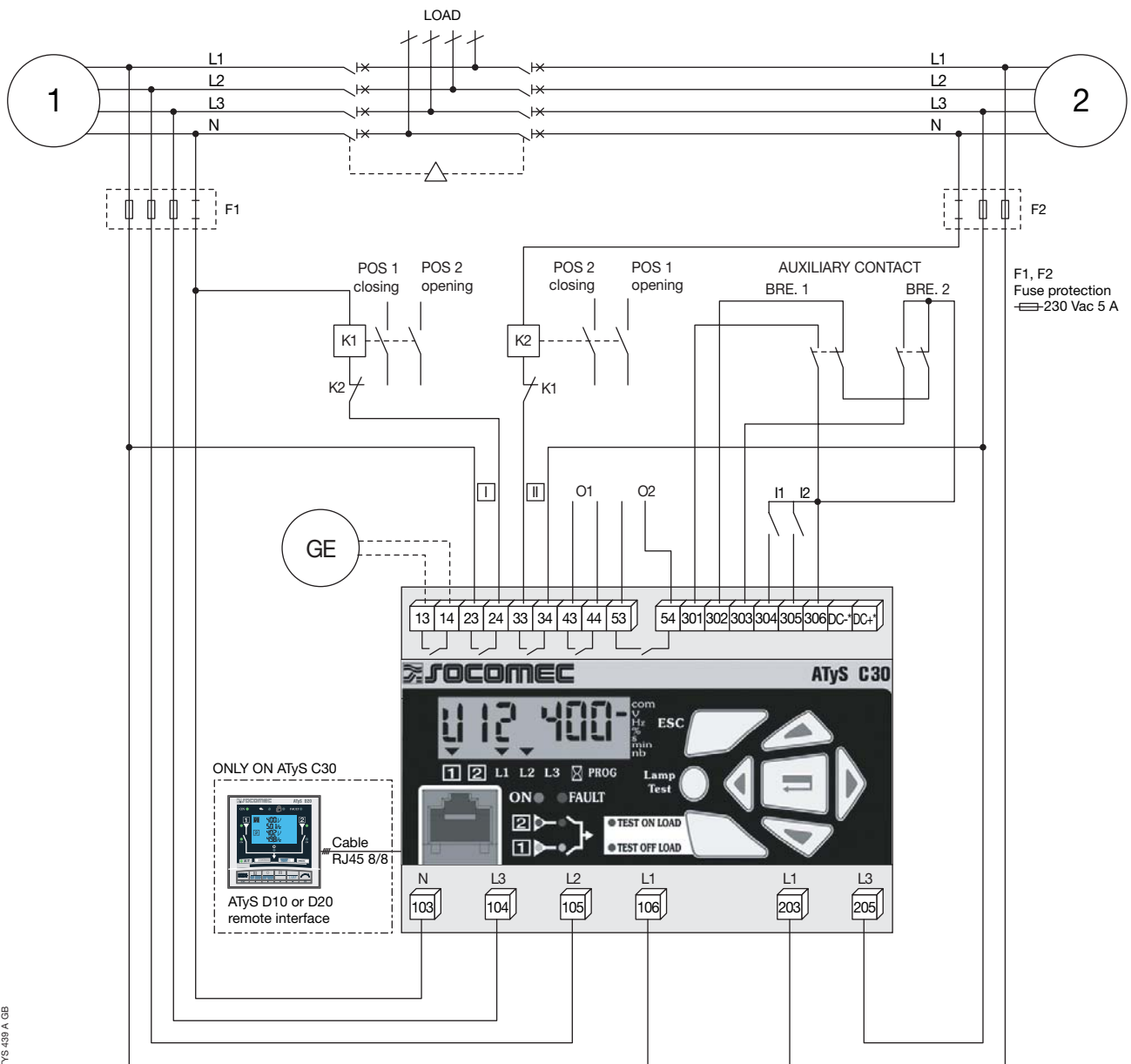

* Only on DC versions.



Maximum control cables length = 10 m.
In case of longer distance, insert control relays.



Remote interfaces maximum connection cable (RJ45) = 3 m.

Control circuits

400 Vac (P-P) APPLICATION WITH NEUTRAL CONDUCTOR CIRCUIT BREAKER TYPE TECHNOLOGY

► **Electrical interlocking not integrated**

- Configure the type of control logic in breaker • Automatic Power supply 203-205 or 104-106 (see Programming chapter)
- Automatic Power supply 203-205 or 104-106 (see power supply chapter).

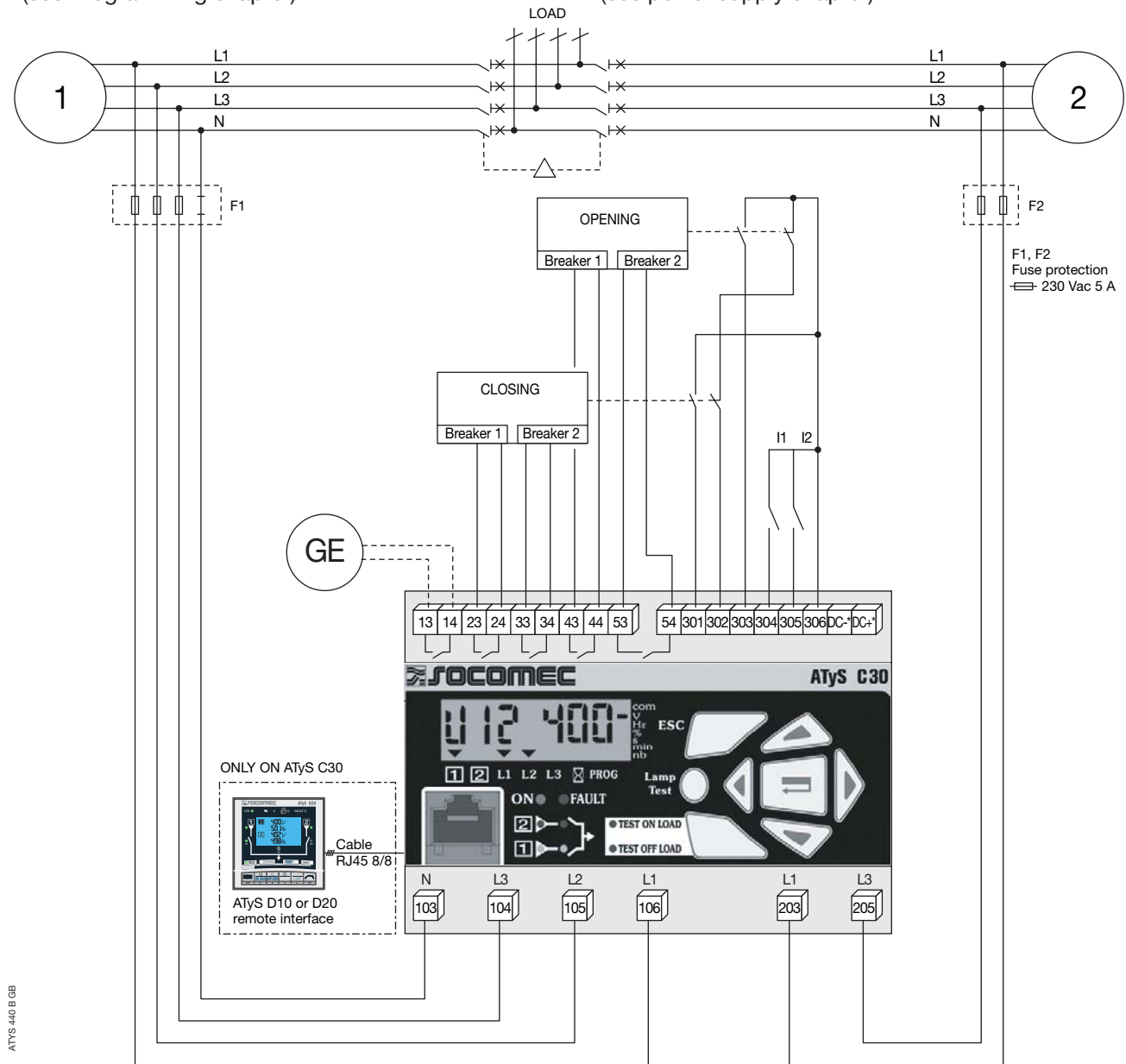

* Only on DC versions.

⚠ Maximum control cables length = 10 m.
In case of longer distance, insert control relays.

⚠ Remote interfaces maximum connection cable (RJ45) = 3 m.

⚠ This drawing is not including the electrical interlock.

⚠ It might be necessary for some breakers not to set up OMR and OMF timers to 0. (refer to programming)

Control circuits

Denomination	Terminals	Description	Characteristics	Recommended section
Power supply Source ^[1]	N (103)	Neutral	440 V ac (phase-phase) maximum, 50/60 Hz 254 V ac (phase neutre) maximum, 50/60 Hz	1.5 mm ²
	L3 (104)	Phase 3		
	L2 (105)	Phase 2		
	L1 (106)	Phase 1		
Power supply Source ^[2]	L1 (203)	Phase 1	440 V ac (phase-phase) maximum	1.5 mm ²
	L3 (205)	Phase 3		
Power supply DC ⁽¹⁾ 12Vdc, 24Vdc	DC-	Power supply 0 V	From 9 V dc to 30 V dc	1.5 mm ²
	DC+	Power supply +V dc		
Genset ⁽²⁾ start signal	13	Genset start/stop relay - 2 stable positions	Dry contact 5A AC1/250 V	1.5 mm ²
	14	Programmable state - factory setting = NO, close to start		
Control (impulse, contactor and breaker mode to programm)	23	Impulse mode: order to close source ^[1]	5 A AC1/250 V	1.5 mm ²
	24	Contacteur mode: order to close contactor source ^[1] Breaker mode: order to close breaker source ^[1]		
	33	Impulse mode: order to close source ^[2]	5 A AC1/250 V	1.5 mm ²
	34	Contacteur mode: order to close contactor source ^[2] Breaker mode: order to close breaker source ^[2]		
	43	Impulse mode: order to reach position 0	5 A AC1/250 V	1.5 mm ²
	44	Contacteur mode: programmable relay O1 Breaker mode: order to open breaker source ^[1]		
	53	Impulse mode: programmable relay O2	5 A AC1/250 V	1.5 mm ²
	54	Contacteur mode: programmable relay O2 Breaker mode: order to open breaker source ^[2]		
Information auxiliary contacts	301	Auxiliary contact information position 1 AC1	Do not connect to any power supply	1.5 mm ²
	302	Auxiliary contact information position 0 AC0		
	303	Auxiliary contact information position 2 AC2		
Programmable Inputs	304	Programmable input In1	Do not connect to any power supply	1.5 mm ²
	305	Programmable input In2		
Common input	306	Specific voltage supply Common terminals 301 to 306	Do not connect to any power supply	1.5 mm ²
Remote interface connection	RJ	Remote interface ATyS D10 or D20	Maximum connection cable 3 m	RJ45 8/8

(1) Only on DC version

(2) Refer to programming, Setup, to modify relay state.

Electrical operation

POWER SUPPLY

ATyS C20/C30 integrates 2 power inputs (104-106, 203-205), and consider the available source to keep the product operational. Product supplied when voltage on terminals ≥ 100 Vac

For the DC version, there is only one power supply input (DC-, DC+).

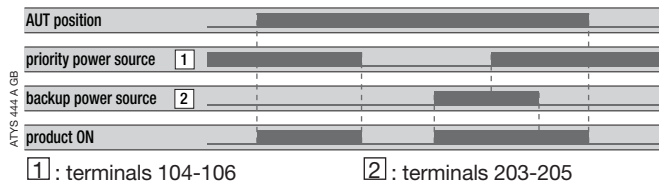

OPERATION

ATyS C20/C30

- ▶ Presentation
- ▶ Operational modes
- Programming
- Operation
- Visualisation
- Automatic sequences

Presentation

The product allows:

- sources control,
- automatic transfer control in AUT mode,
- parameters configuration,
- voltage and frequency metering,
- system state display,
- alarm or fault indication,

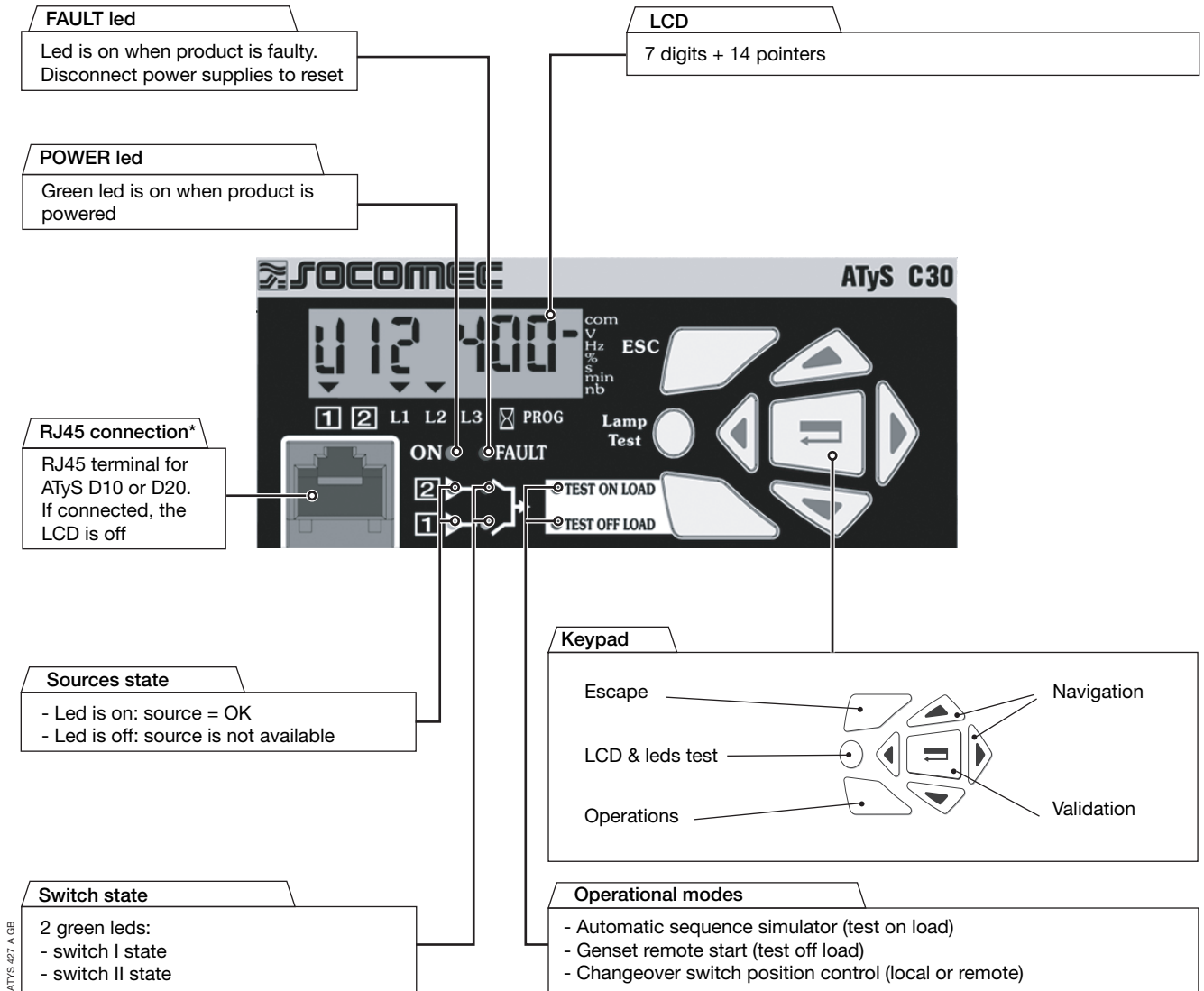

* only on ATyS C30.

SOFTWARE VERSION

Displayed after reset.
(3 minutes power off action to allow reset).

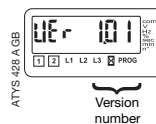

Operational modes

VISUALISATION

Measured values & parametered timers display. Always accessible without code.

PROGRAMMING

Parameters configuration. Password access (code 1000 from factory).
The manual mode must be programmed on an input if required.

OPERATION

Test sequences. Password access (code 4000).

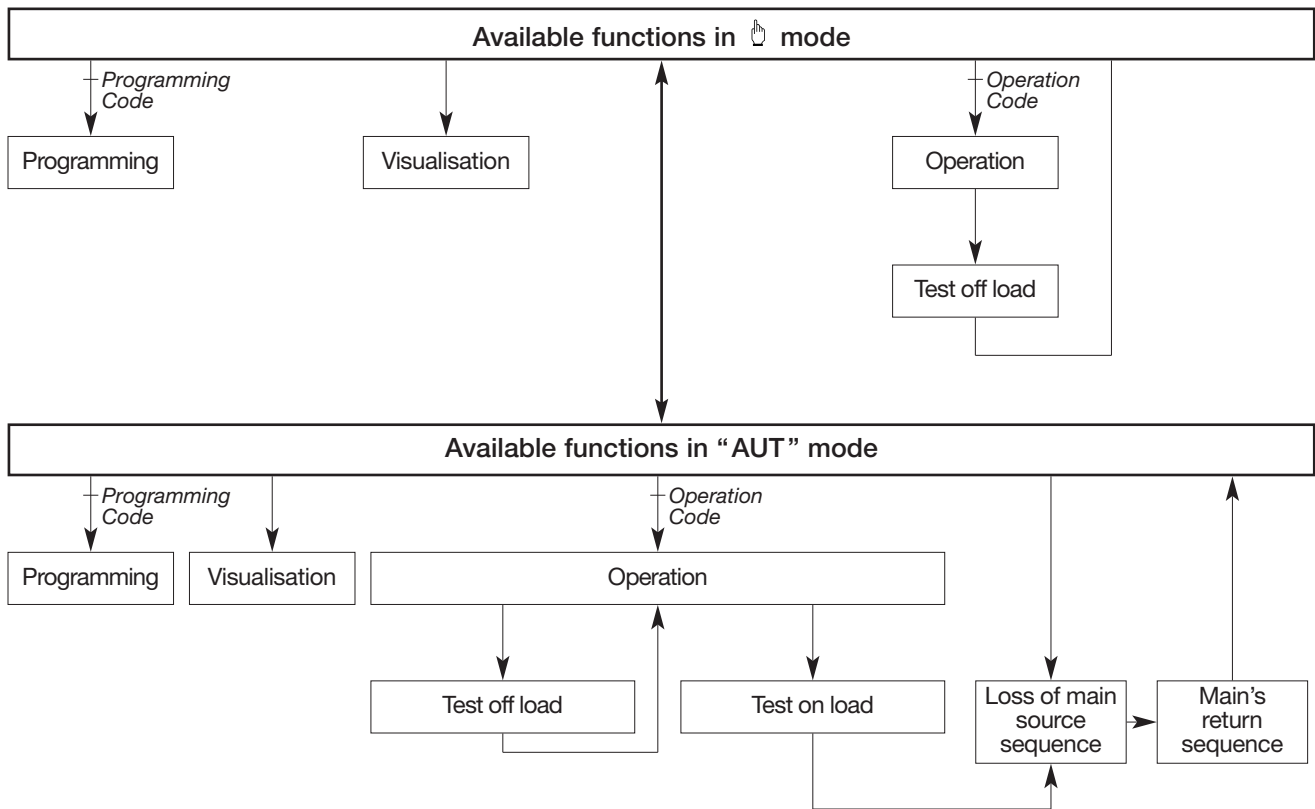

PHASES ROTATION CONTROL

Function available only on source 1 in case of 3NBL, 4NBL and 41NBL network.
If a fault is detected, the source 1 is not indicated as available.

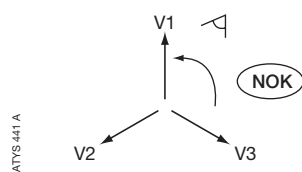
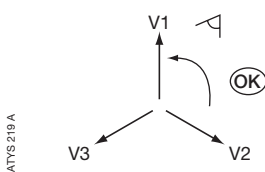

displayed according to faulty source.

Programming

- This mode allows product parameters configuration
- Always accessible in  mode (when programmed on an input)
- Always accessible in AUT mode, changeover switch on priority source, priority source being available
- Not accessible when “test off load”, “test on load” functions are active or during automatic sequence.



Parameters requiring programming before use:

- type of network
- nominal voltage
- nominal frequency
- control logic
- number of auxiliary contact.

> Navigation in the menus



- **Parameters access:** Press “up”, “down”, “left” & “right” push buttons



- **Parameter modification:** press “left” & “right” push button to access the parameter to modify
Press “up” and “down” push buttons to modify the parameter and “validate”



- **Return to main menu:** press “ESC” push button
Value is only modified after validation

> Programming access



- **Step 1:** press and hold for 5 s “validation” push button



- **Step 2:** enter code (factory code = 1000) using navigation push buttons



- **Step 3:** press validation push button

> Programming exit



- Press and hold for 5 s “validation” push button

Programming

PROGRAMMING MENU ARCHITECTURE

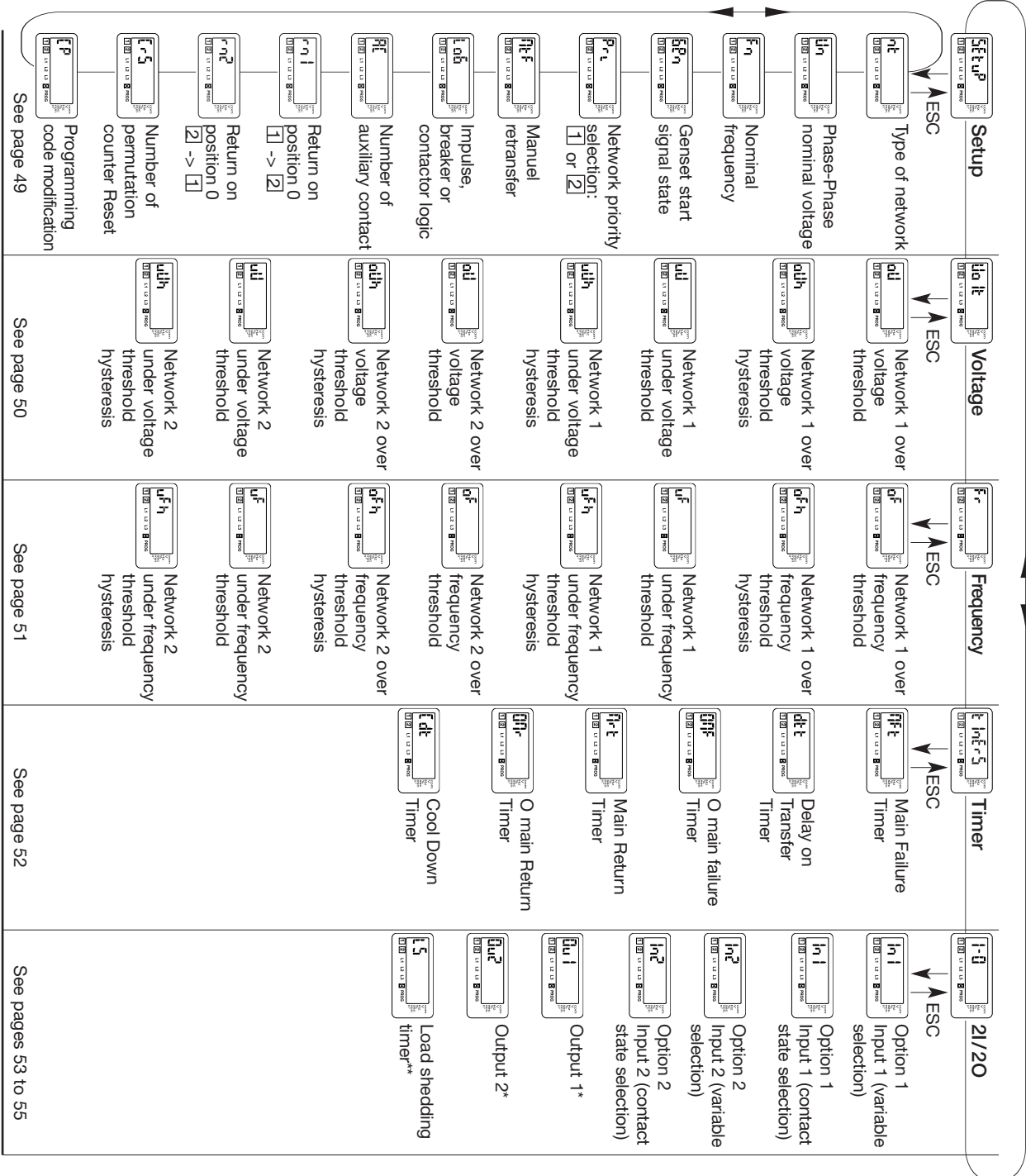

See page 49

See page 50

See page 51

See page 52

See pages 53 to 55

* Availability of output functions depending on control logic selection (impulse, breaker or contactor logic).
 ** Displayed if LS variable has been selected.

Programming

PARAMETER MODIFICATION

> **Example:**

Modify network 1 nominal voltage from 400 to 230 V.

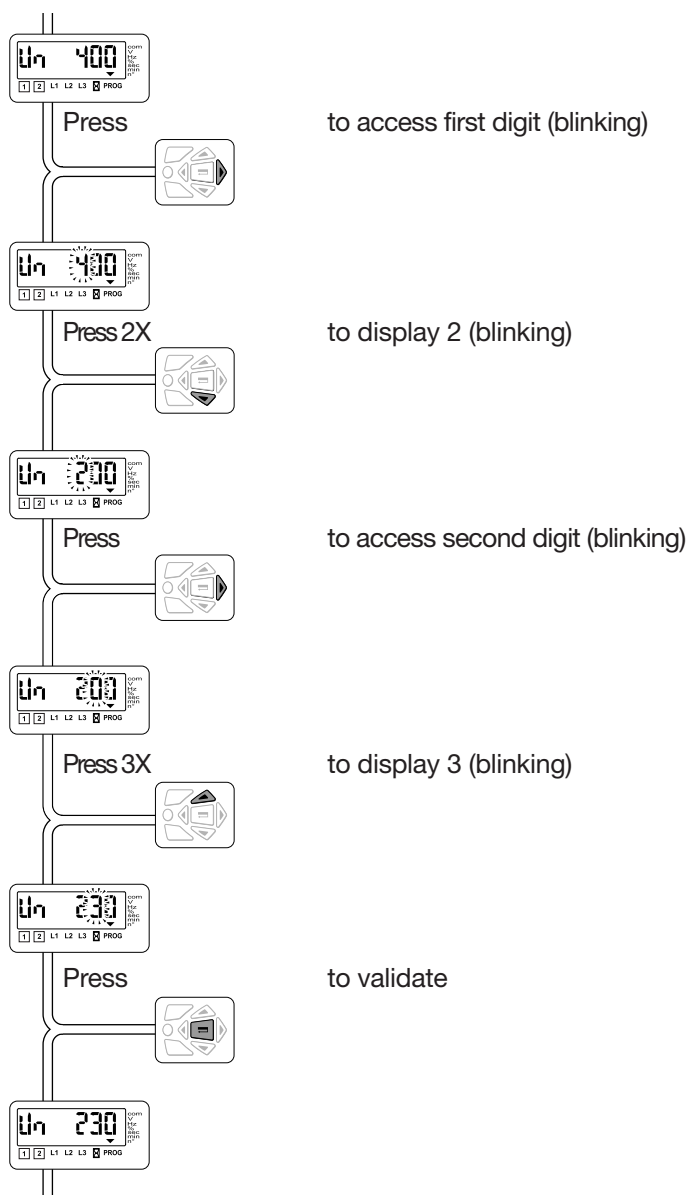









ATI074 A

Programming

PARAMETERS CHARACTERISTICS

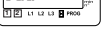
> Menu Setup 

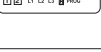
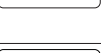
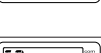
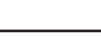
LCD	Denomination	Definition	Setting range	Default values
	Type of network*	Number of active conductors of controlled network (refer to annexes)	1BL, 2BL, 2NBL, 3NBL, 4NBL, 41 NBL	4NBL
	Network nominal voltage	Phase-Neutral voltage for 1BL & 41NBL Phase-Phase voltage for others	from 100 V to 400 V	400 V
	Network nominal frequency	Network nominal frequency	50 Hz or 60 Hz	50 Hz
	Genset start signal state	Normally opened or closed	NO or NC	NO
	Network priority selection	Keypad selection (1 or 2) Also possible via external contact using option	1 or 2 (1 or 2)	1 (1)
	Manual Retransfer	Activation of the feature	Yes or No	No
	Type of control logic selection	Impulse, contactor or breaker.  It might be necessary for some breakers not to set up OMR and OMF timers to 0 (2 sec. for exemple).	Imp, con, brE	Imp
	Number of auxiliary contact	Depending on the number if available auxiliary contacts (switch, contactor, breaker)	0, 2, 3	2
	Parameter 1, return in position 0	Allows to go to position 0 in case of voltage or frequency outage (out if the defined U, f range)	Yes or No	No
	Parameter 2 return in position 0	Allows to go to position 0 in case of voltage or frequency outage (out if the defined U, f range)	Yes or No	No
	Number of permutation counter Reset	Allows source 1 -> source 2 automatic sequences counter reset	Yes or No	No
	Programming code modification	Possible to change the programming code	from 0000 to 9999	1000

* Refer to annexes.

(1) It might be necessary for some breakers not to set up OMR and OMF timers to 0. (2 sec.)

Programming

> Volt Menu



Threshold detection starts from the loss of source or source return sequence.

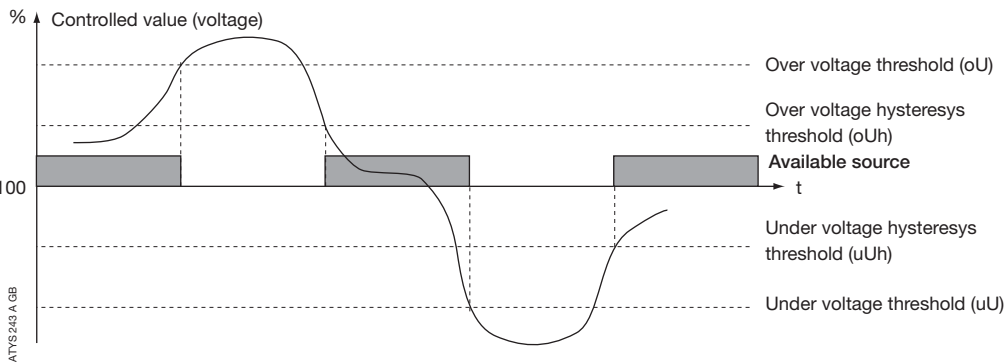

LCD	Denomination/Definition	Setting range	Default values
	Network 1 over voltage threshold	From 102 to 120 %	115 %
	Network 1 over voltage threshold hysteresis	From 101 to 119 % (< oU)	110 %
	Network 1 under voltage threshold	From 80 to 98 %	85 %
	Network 1 under voltage threshold hysteresis	From 81 to 99 % (> uO)	95 %
	Network 2 over voltage threshold	From 102 to 120 %	115 %
	Network 2 over voltage threshold hysteresis	From 101 to 119 % (< oU)	110 %
	Network 2 under voltage threshold	From 80 to 98 %	85 %
	Network 2 under voltage threshold hysteresis	From 81 to 99 % (> uU)	95 %



Values definition: % of nominal values
Hysteresis values range is limited by thresholds values.

Programming

> Frequency Menu

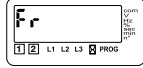

Threshold detection starts from the loss of source or source return sequence.

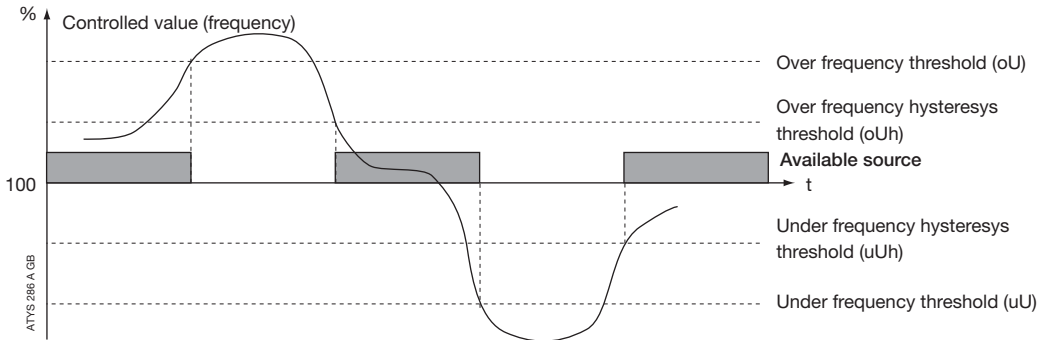

LCD	Denomination/Definition	Setting range	Default values
	Network 1 over frequency threshold	From 101 to 120 %	105 %
	Network 1 over frequency threshold hysteresis	From 100.5 to 119.5 % (< oF)	103 %
	Network 1 under frequency threshold	From 80 to 99 %	95 %
	Network 1 under frequency threshold hysteresis	From 80.5 to 99.5 % (> uF)	97 %
	Network 2 over frequency threshold	From 101 to 120 %	105 %
	Network 2 over frequency threshold hysteresis	From 100.5 to 119.5 % (< oF)	103 %
	Network 2 under frequency threshold	From 80 to 99 %	95 %
	Network 2 under frequency threshold hysteresis	From 80.5 to 99.5 % (> uF)	97 %



Values definition: % of nominal values
Hysteresis values range is limited by thresholds values.

Programming

> Menu Timer

LCD	Denomination	Definition	Setting range	Default values
	Main Failure Timer	Delays priority network failure detection	from 0 to 60 s	5 s
	Delay on transfer Timer	Standby network stability validation before transfer	from 0 to 60 s	5 s
	O Main failure Timer	Rest in O position when transferring from main network to secondary network	from 0 to 20 s	0 s
	Main return Timer	Main network stability validation before re-transfer	from 0 to 30 min	2 min
	O main return Timer	Rest in O position when re-transferring from standby network to main network	from 0 to 20 s	0 s
	Cool down Timer	Allows generator cooling down period after load's retransfer from standby source (generator) to Main source	from 0 to 30 min	4 min





Programming

> Inputs/Outputs Menu



 Output relays are NO type (construction) and can not be configured as NC.

Input state can be configured: NC or NO.

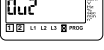
LCD	Denomination/Definition	Setting range	Default values
	Input 1	Ft1, Ft2, Ft3, Ft4, Pri, Mtf, / S2A, MAN, CtS, tol, tfl, EJP	/
	Input 1 state	NO, NC, /	NO
	Input 2	Ft1, Ft2, Ft3, Ft4, Pri, Mtf, / S2A, MAN, CtS, tol, tfl, EJP	/
	Input 2 state	NO, NC, /	NO
	Output 1	S1A, S2A, LS, /	/
	Output 2	S1A, S2A, LS, /	/

Programming

▶ Inputs/Outputs Menu Inputs



Variable	Description
Ft1	Fault input 1. The fault led is blinking as soon as the input is active and Ft1 is displayed on LCD. Reset when the input is de-activated
Ft2	Fault input 2. The fault led is blinking as soon as the input is active and Ft2 is displayed on LCD. Reset when the input is de-activated
Ft3	Fault input 3. The fault led is blinking as soon as the input is active and Ft3 is displayed on LCD. The transfer switch is immediately driven in 0 position (only in contactor mode). Keypad action (Validation) necessary to Reset the fault
Ft4	Fault input 4. The fault led is blinking as soon as the input is active and Ft4 is displayed on LCD. The transfer switch is immediately driven in 0 position (only in contactor mode). Keypad action (Validation) necessary to Reset the fault
Pri⁽¹⁾	Priority network selection. Network 1 has priority when input is not activated. Network 2 has priority if input is active
Mtf	Remote manuel re-transfer. Feature identical to manual retransfer on keypad. Re-transfer from priority network to backup network is allowed from input activation (1 s front). The Mtf variable in the setup menu must be selected (Yes) to allow input recognition
S2A	Information source 2 available (Genset) used instead of voltage/frequency measurement (inhibited when S2A is selected)
Man	Information transfer system in manual mode All automatic commands (+ test on load) are inhibited as soon as the input is activated
CtS	Remote transfer control. Possible to initiate transfer from priority source to backup source before DTT ends. If DTT is set to its maximum value (60s), the transfer is initiated as soon as the input is activated (1 s front)
tol	Remote test on load. Started from input activation. Re-transfer is blocked until input de-activation
tfl	Remote test off load Started from input activation (remote genset start/stop)
EJP	2 inputs are automatically affected to EJP <ul style="list-style-type: none"> • input 1 for EJP advice, to start generator • input 2 to transfer on emergency source Retransfer is activated when input 2 dissapears



(1) This information is the only considered in case of option configuration. Programming variable Pri is then inhibited.

• EJP cycle

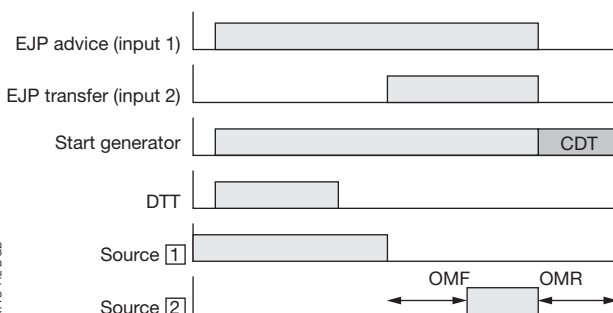

ATyS 442 E GB

Programming

> Inputs/Outputs Menu Outputs

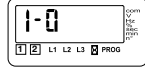

Variable	Description
S1A	Source 1 available. Output activated as soon as source 1 is considered available (similar to front led source 1)
S2A	Source 2 available. Output activated as soon as source 2 is considered available (similar to front led source 2)
LS	Load shedding relay. LS timer corresponds to time available to disconnect the shed loads. The relay is activated before permutation on standby network according to LS timer. The relay is de-activated after retransfer on mains network and LS timer countdown

In case of LS function selection, it is required to configure associated LS timer.

Output	Function	Default Value	Setting range
	S1A, S2A, LS, /	For LS: 0 to 60 s (≤ DTT)*	For LS: 3 s

* In case of DTT variable configuration below LS, LS will be automatically set to DTT value.

• **Example:** LS configuration (output relay Ou1, 3 seconds):

The load shedding can't be used with the priority network (priority source = source 2). In this case, LS output is not valid.

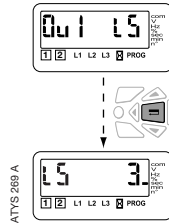

• **Load shedding cycle**

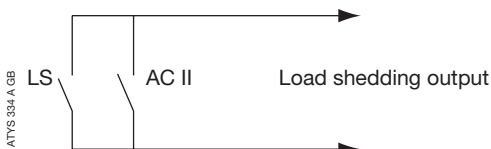
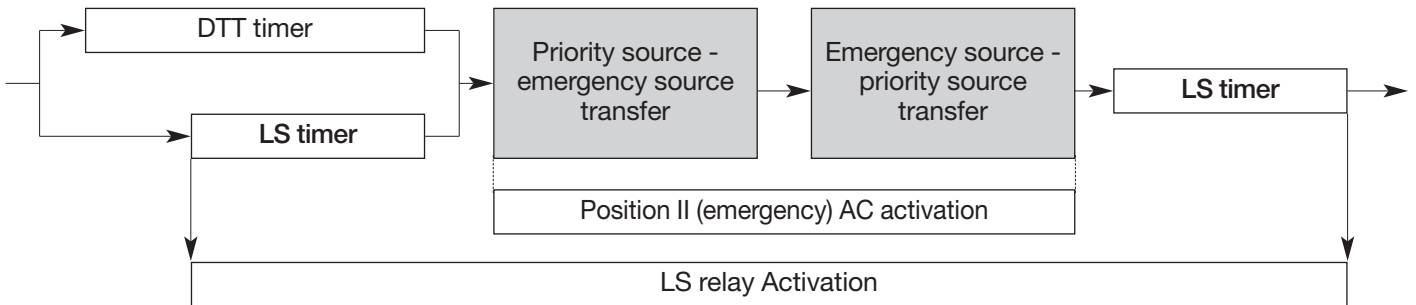



! The output is de-activated in case of loss of power. It may then be required to put in parallel with the load shedding output relay, position 2 auxiliary contact. This would avoid taking back the load in case of loss of emergency source in emergency position.

Operation

PRESENTATION

This mode allows in manual mode (not padlocked) to start a test off load. In automatic mode, it allows to start a test, on or off load.



Enter operation mode:

-  • **Step 1:** press and hold the “TEST” push button for 5 s
-  • **Step 2:** enter the operation code (CE) using navigation push buttons (code 4000)
-  • **Step 3:** press “validation” push button

Exit operation mode:

-  Press and hold the “TEST” push button for 5 s or automatic exit without action during around 2 min

Navigate in operation mode:

-  • Press “TEST” push button to access different features
-  • Press “validation” push button to activate required function

OPERATION MODE ARCHITECTURE

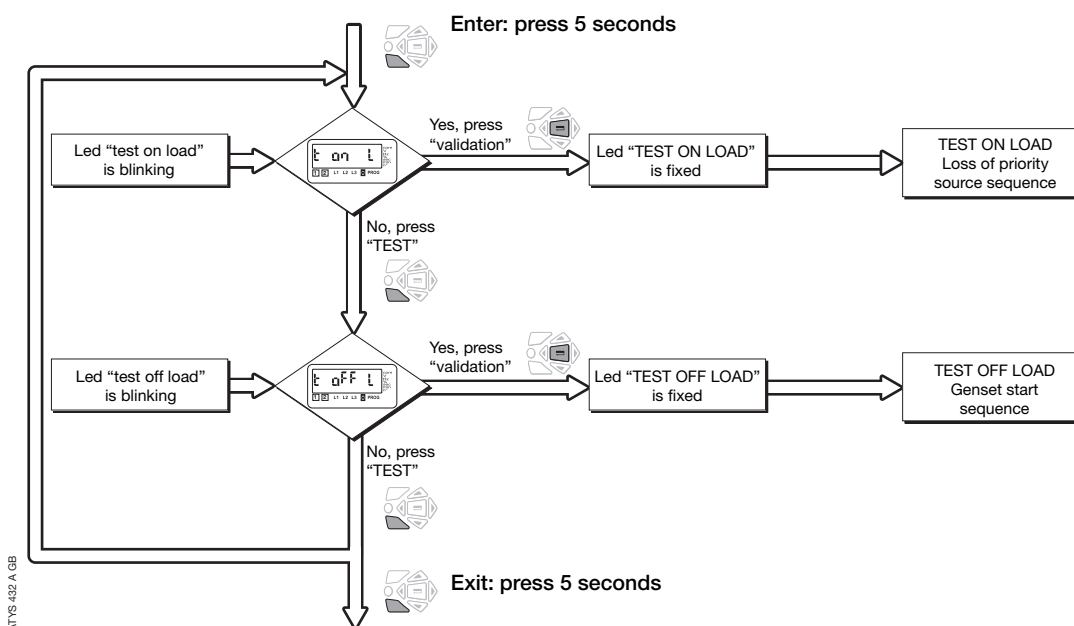





ATyS 432 A GB

Operation

TEST OFF LOAD (ACCESSIBLE IN AUT / MODES)

It can be activated from:

- operation mode
- ATyS D20 interface
- programming input (TFL) if selected.

This test is made for applications where emergency source  is typically a genset (priority source must be source ). This test can be activated, in automatic mode, changeover switch in position , source  available.

> Description

- This mode will start and stop remotely genset operation without load transfer
- The test is not possible during an automatic sequence

> Keypad activation

After operation mode access, press mode push button to make the test off load led blinking and validate to start the sequence.

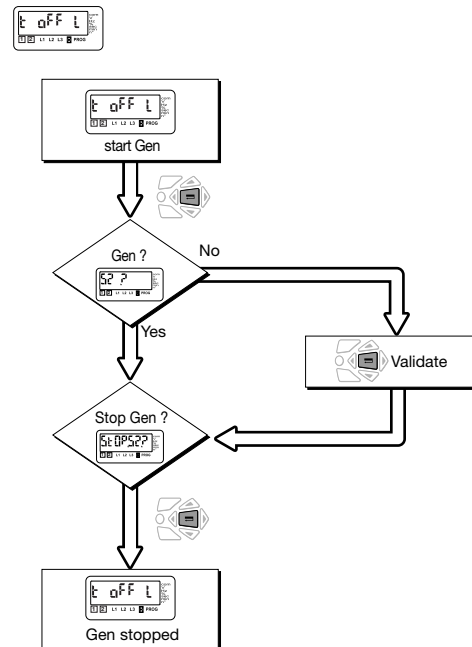

TEST ON LOAD (ACCESSIBLE IN AUT MODE)

It is activated from:

- operation mode
- ATyS D20 interface
- programming input (TOL) if selected.

> Description:

- This test simulates a loss of priority source situation. The sequence generates load transfer from priority source to emergency source after backup source start up operation (in case of genset). The return sequence always keeps manual re transfer feature activated (from priority source availability). All timers are counted down.

> Keypad activation

After operation mode access, press mode push button to make test on load led blinking and validate to start a cycle.

The test is only possible in automatic mode, the changeover switch in priority source position, priority source being available.

> Keypad or remote operation

 Manual retransfer to validate on keypad. In retransfer sequence from emergency source to priority source, the MRT count down is set to 10 seconds (maximum), unless a lower value has been programmed.





 Automatic cycle keeps priority.

> Remote activation via specific input



It is also possible to start a test on load remotely with the programming input TOL if selected. The cycle is started from contacts closure. The re-transfer is initiated from contacts opening.

 The re-transfer from emergency source to priority source is blocked and only authorized after manual retransfer validation (keypad activation) or terminals opening.

 Start gen relay is closed if source  has priority.

Visualisation

PRESENTATION

- This mode allows parameters to be displayed independently from mode  /AUT switch position (if  programmed on input)
- No code required to access parameters visualisation
- Without any action during 5 seconds on the keypad, the LCD displays voltage available on active network. In case of changeover switch on 0 position, priority network voltage is displayed.

Navigation in visualisation mode:



- Press “up” and “bottom” push buttons to access required parameter



- Press “left” and “right” push buttons to navigate in the different menus

Visualisation

VISUALISATION ARCHITECTURE MODE

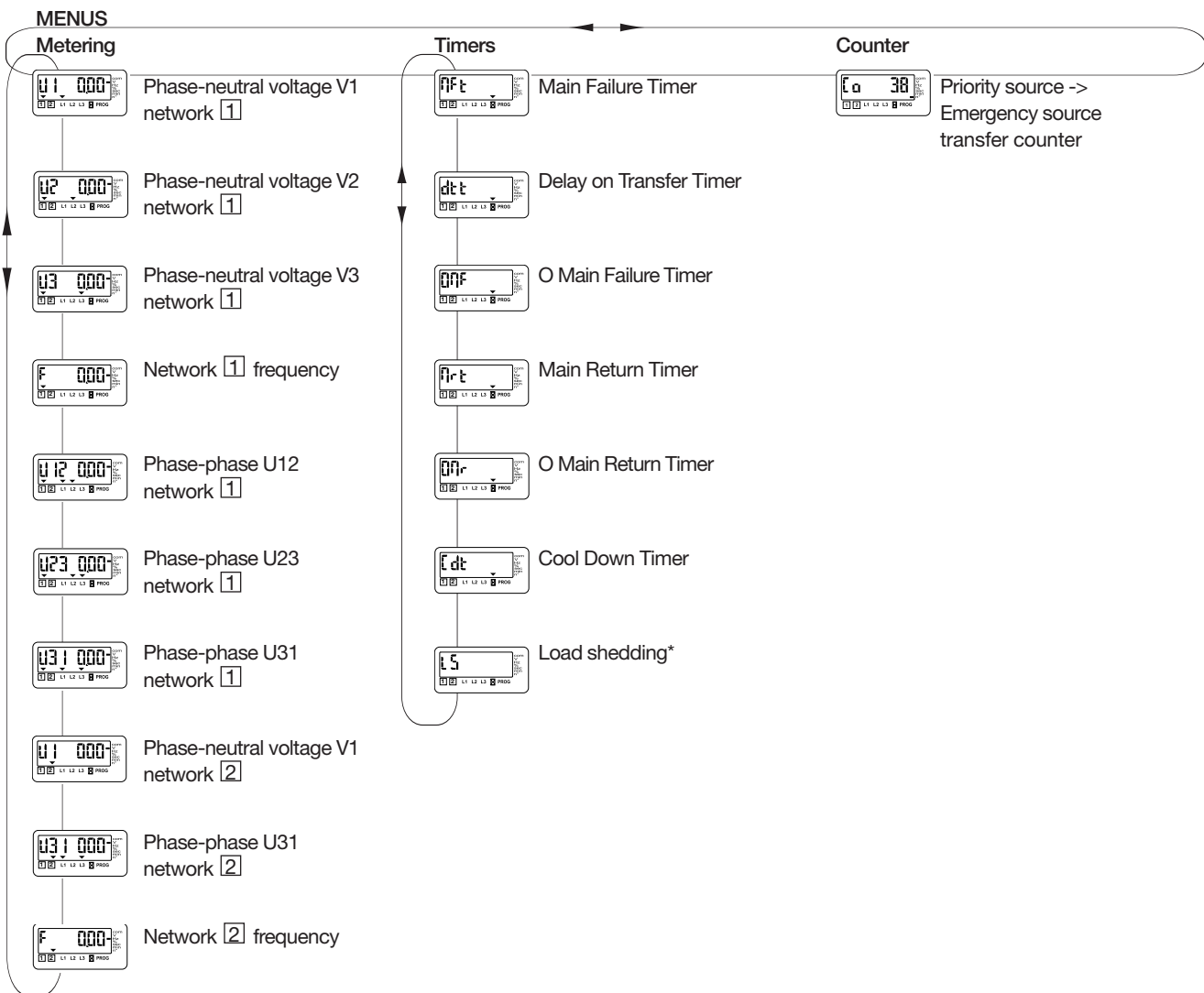

* If selected.



All values indicated might not be available according to programmed network. Refer to annexes.

Automatic sequences

MANUAL MODE / AUTOMATIC MODE

> Manual mode - Automatic mode permutation/power supply reappearance

- As soon as man input disappears (if selected), the automatic mode is active
- Voltages and frequencies are verified to define new stable position of the changeover switch
- The same table can be taken into account after complete power supply loss (the product must be completely discharged to reset = 3 minutes.)

Refer to timer menus for MFT, MRT or DTT timers definition.

> New stable position of the changeover switch

Changeover switch initial position	Sources availability	New position
Priority source	Priority source available, emergency source available or unavailable	Priority source
Priority source	Priority source unavailable for MFT time period, emergency source available or unavailable	Emergency source. If emergency source unavailable start emergency source first and wait for DTT timer period before transfer
Emergency source	Emergency source available, priority source unavailable	Emergency source
Emergency source	Emergency source available, priority source available for MRT time period	Priority source
Emergency source	Emergency source not available, priority source available	Priority source
Position 0	Priority source available, emergency source unavailable	Available source to count down MRT before transfer to priority source
Position 0	Priority source available, emergency source unavailable	Priority source
Position 0	Priority source unavailable, emergency source available	Emergency source
Position 0	Priority source unavailable, emergency source unavailable	No action (because no supply). When supply becomes available change to priority source or emergency source



The switch transfers to new stable position as soon as Automatic mode is active.

LOSS OF PRIORITY SOURCE AUTOMATIC SEQUENCE

This sequence is started as soon as the switch is in automatic mode and in priority position (position I - source 1).

- source 1 is available
- transfer switch is in position I
- source 2 is available or unavailable

> Available source

Source being within programmed voltage and frequency settings, phases rotation being correct.

> Specific feature: remote transfer control

It is possible to transfer from main source to emergency source before DTT finishes up and to allow transfer with CTS option if selected on an input. DTT is automatically set up to its maximum value as soon as CTS is selected.

Automatic sequences

RETURN TO PRIORITY SOURCE

This sequence is activated as soon as the changeover switch is in automatic mode and in emergency position (position II):

- the priority source [1] is not available

> Specific feature: manual re-transfer

- When priority source comes back, it can be required not to automatically retransfer and wait for a more adequate moment.
- It is possible, validating manual retransfer feature (refer to programming), to block the re-transfer.

It is initiated from:

- validation push button locally or on ATyS D20
- via a programming input if MTF option is selected.

- the changeover switch is in emergency position (ex: genset)
- the emergency source [2] is available.



Manual retransfer = validation press
Or optional input activation, Mtf feature

> Sequence description

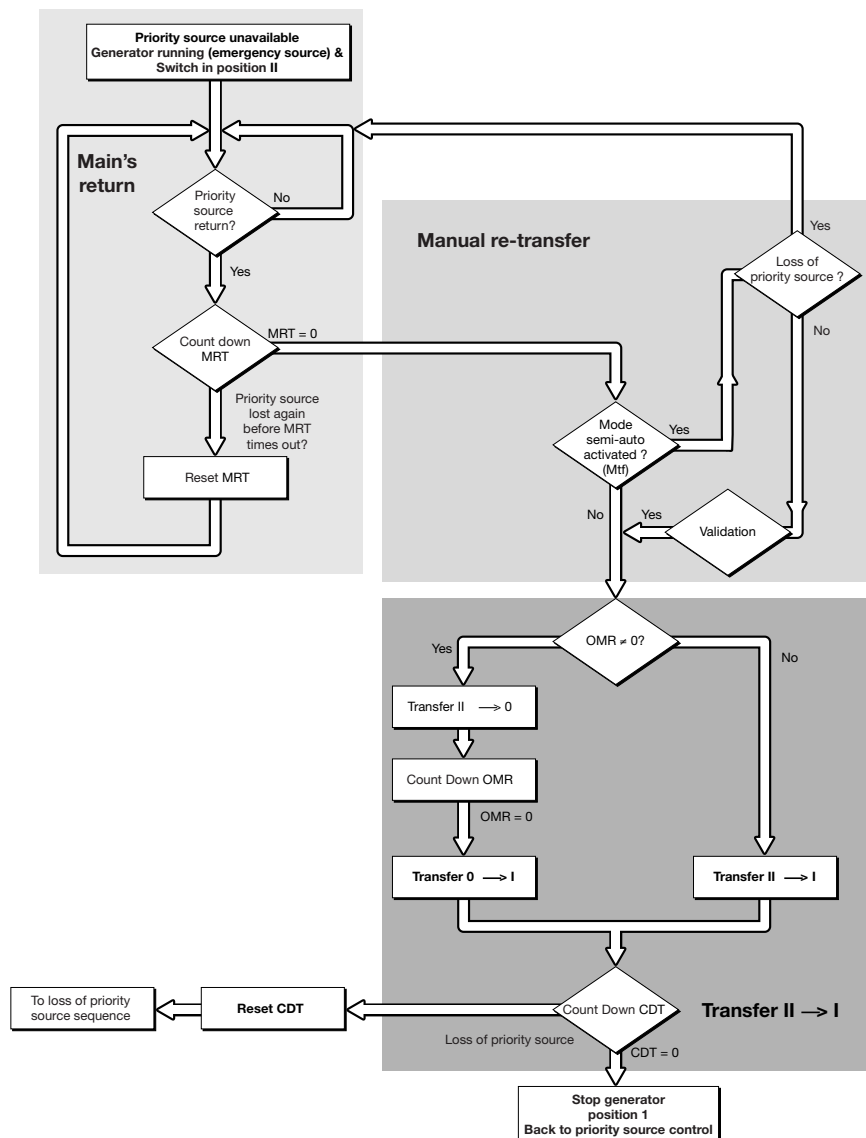

TROUBLESHOOTING GUIDE

ATyS C20/C30

STATE	ACTION
Electrical operation is not operational	<ul style="list-style-type: none"> • Verify voltage applied on terminals 100 Vac to 440 Vac or 9 Vdc to 30 Vdc for DC version • Verify state MAN of input if selected
Product is faulty (fault is active) FT1, FT2, FT3, FT4	<ul style="list-style-type: none"> • Disconnect power supply to try to reset the fault • In case of programming inputs FT1 or FT2, verify if external fault is not active (automatic reset). • In case of programming inputs FT3 or FT4, verify if external fault is not active. The fault must be reset or keypad (validation push button)
Source available led is never active when available	<ul style="list-style-type: none"> • Press test lamp to verify led is operational (push 5 seconds) • Verify nominal preset values (voltage and frequency) • Verify voltage and frequency thresholds • Verify phases sequence
The changeover switch does not transfer after loss of main	<ul style="list-style-type: none"> • Verify state MAN of input, if selected • Verify emergency source is available (ex: genset is started) • Verify voltage applied on terminals
Test on load and off load can not be activated from keypad	<ul style="list-style-type: none"> • Verify password to access test (4000) • Verify state MAN of input, if selected
The changeover switch does not re-transfer after main's return	<ul style="list-style-type: none"> • Verify MRT is counted down • Verify state MAN of input if selected • Verify manual retransfer feature is not active (press validation to allow retransfer)
Retransfer has been realised but emergency source is still running (did not stop)	<ul style="list-style-type: none"> • Verify CDT is counted down • Verify Start Gen output relay command, terminals 13-14 (disconnect connector if required)
Electrical operation not according to commands	<ul style="list-style-type: none"> • Verify control logic (impulse, breaker or contactor mode)
The product is in faulty position	<ul style="list-style-type: none"> • Verify the number of AC (auxiliary contacts) in the setup menu. It must be in conformity with the number of AC connected • Verify the switch position
Error LCD Err XXXX	<ul style="list-style-type: none"> • Send the product back to the manufacturer

Networks analysis

TYPES OF NETWORKS

▶ Three phases network with neutral - 4NBL

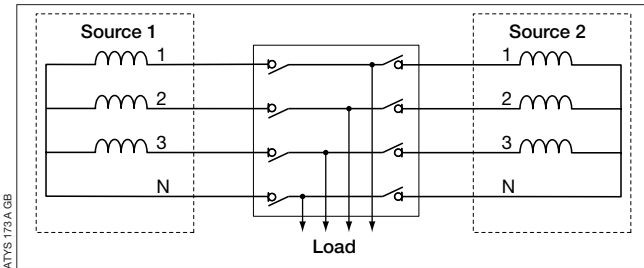

▶ Two phases network (with midpoint) - 2NBL

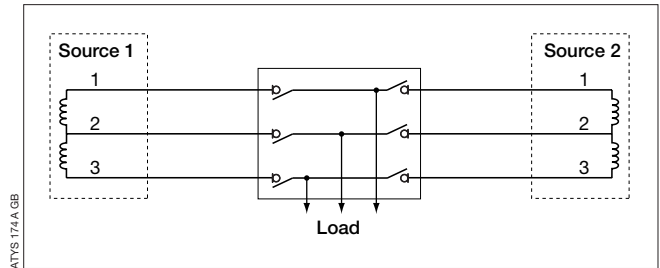

▶ Phase-Phase network without neutral - 2BL

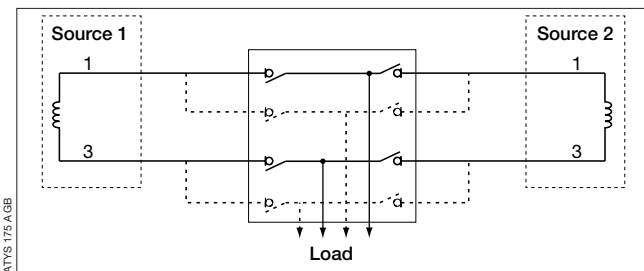

▶ Single phase network with neutral (phase-neutral) - 1BL*

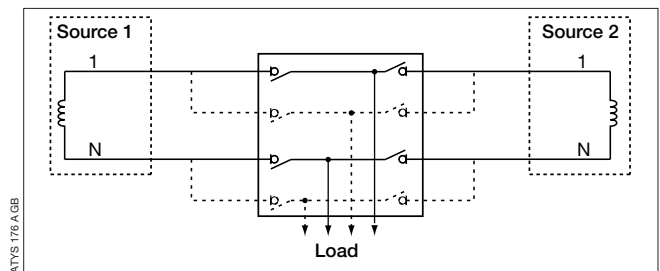

* to power supply the product, make a strap between 103 (N) and 104 terminals (power supply input 104-106 on source 1).

▶ Three phases network without neutral - 3NBL

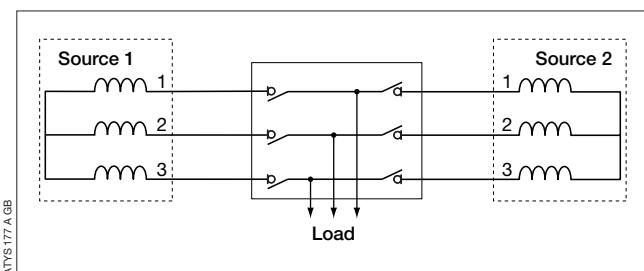

▶ Three phases network with neutral on source 1
Single phase network with neutral on source 2 - 41 NBL

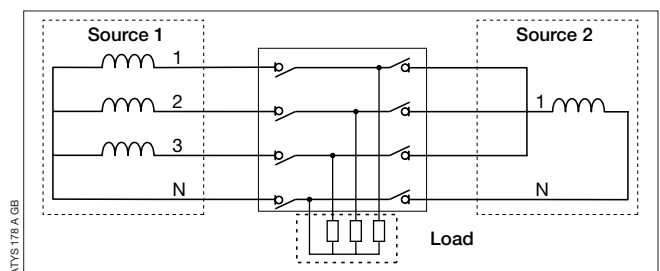







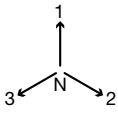
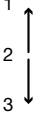

Only single phase loads.

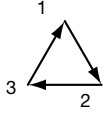
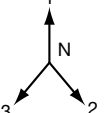
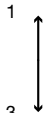
Programming and connections ATyS C30

ATyS integrates all identified networks in his programm.
It is necessary to verify this parameter before use.

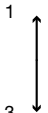
THREE PHASES SENSING ON SOURCE 1 - SINGLE PHASE SENSING ON SOURCE 2

		3 phases 4 wires	1 phase 3 wires	1 phase 2 wires	1 phase 1 wire	3 phases 3 wires	3 phases
Prog. ATyS		4NBL	2NBL	2 BL	1BL*	3NBL	41NBL
Source 1 (active connectors)							
Source 2 (active connectors)							
Sensing parameters available	Source 1	U12, U23, U31, U1, U2, U3	U12, U23, U31	U31	U1	U12, U23, U31	U1, U2, U3
	Source 2	U31	U31	U31	U1	U31	U1
Controls	Source 1	U12, U23, U31	U12, U23, U31	U31	U1	U12, U23, U31	U1, U2, U3
	Source 2	U31	U31	U31	U1	U31	U1
Example Un = 240 V	Source 1	U12 = U23 = U31 = 240 V	U31 = 240 V	U31 = 240 V	U1 = 240 V	U12 = U23 = U31 = 240 V	U1 = U2 = U3 = 240 V
	Source 2	240 V	240 V	240 V	240 V	240 V	240 V

* to power supply the product, make a strap between 103 (N) and 104 terminals (input power supply 104-106 on source 1).

HEAD OFFICE

SOCOMEK GROUP SWITCHING PROTECTION & UPS
S.A. capital 10 836 600 €
R.C. Strasbourg 548500 149 B
1, Rue de Westhouse - B.P. 10 - F-67235 Benfeld Cedex - FRANCE

SALES MANAGEMENT DIVISION

SOCOMEK
95, rue Pierre Grange
94132 Fontenay-sous-Bois Cedex
Tél. +33 01 45 14 63 90
Fax +33 01 45 14 63 38

www.socomec.com